

We build a better future

Robex  
**17z-9A**



\*Photo may include optional equipment.

# Pride at Work

Hyundai Heavy Industries strives to build state-of-the-art earthmoving equipment to give every operator maximum performance, optimal controllability, versatile machine settings and proven technology. Be proud of your work with Hyundai!



\*Photo may include optional equipment.

# Robex 17z-9A

## Machine Walk-Around

### Rugged Upper and Lower Frame

The upper frame is designed with an optimum structure to absorb high stress from outside. Reinforced box section center frame and track frame provide exceptional strength and longer service life to withstand the tough working conditions.

### Compact design

R17Z-9A's compact design allows the operator to work in confined areas, like close to buildings on roadways, and in urban areas. R17Z-9A's variable undercarriage provides easy and efficient operation in any limited space work environment.

### Engine Technology

The R17Z-9A is powered by a proven and reliable, Tier 4 certified KUBOTA D902 Engine. This engine provides efficient fuel combustion and reduced noise.

### Efficient Control System

Control devices are all conveniently located for improved operator comfort and productivity. A safety lever on the left-side console is designed to prevent exiting the cab while hydraulic controls are live.

### Advanced Hydraulic System

The R17Z-9A hydraulic system is precision designed for fast operation with fine control capabilities.

### Comfortable and Durable Cab with Canopy

Canopy frames meet international standards TOPS, ROPS, FOPS, FOG ensuring operator's safety.

### Operator Convenience

An adjustable suspension seat, wrist rests, ergonomically designed joysticks and plenty of leg room help to reduce operator fatigue. An array of indicators and gauges are displayed on the monitor which keep the operator aware of machine performance at all times. The monitoring system includes seven warning indicators, water temperature gauge, fuel gauge and hour meter.

### Easy and Simple Maintenance

The R17Z-9A is equipped with wide opening engine hood for easy access and maintenance. Additional benefits include an easily serviceable air cleaner and centralized grease fittings.

### Extended Life of Components

The R17Z-9A reduces operating costs over time with long life hydraulic oil, shims and bushings.



# Preference

An operator, who sets his machine to his needs, takes pleasure in his work. Operators can fully customize their work environment and operating preferences to fit their individual needs.



\*Photo may include optional equipment.



## OLED Display & ESL Function (Engine Start Limit)

The OLED display is placed to depict the followings: hour meter, oil pressure, battery charge, engine coolant temperature and a fuel gauge. Theft Prevention Function is added.



## Concentrated Controller Position



The left and right control levers are ergonomically located for convenient access. Pilot operated hand levers are easily accessible for controlling the dozer blade and track extension. Easy-to-access control switches on the left side console improve operating comfort and productivity.



A tiltable left-side console allows the operator easier access to the cab. A safety lock system is designed to prevent exiting the cab while hydraulic controls are live. When the safety lever and left side console are positioned upright, hydraulic functions are disengaged.

## Emergency Stop Switch

At the event of an emergency, engines shutdown.



## Two Outlet Sockets

Sockets may be used for multiple purposes.

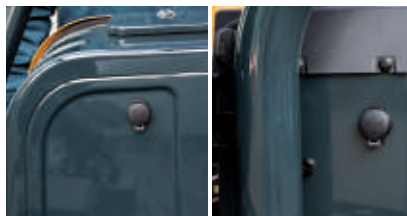

## Operator Comfort

An operator's work environment should be stress free. Hyundai R17Z-9A's adjustable suspension seat, wrist rests, ergonomically designed joysticks and plenty of space help to reduce stress on the operator.

## Front Guard with the Foot Rest

The cross pipe is placed for front guard reinforcement. Also, an operator may use it as a foot rest.



\*Photo may include optional equipment.

# Precision

New technologies designed to improve performance and precision, make the R17Z-9A smooth, fast and easy to control.



\*Photo may include optional equipment.



## Boom Swing (LH : 70° RH : 54°)

The R17Z-9A's boom swing function is designed for efficient work in congested residential and urban areas. The boom can be offset left or right within an operating range.

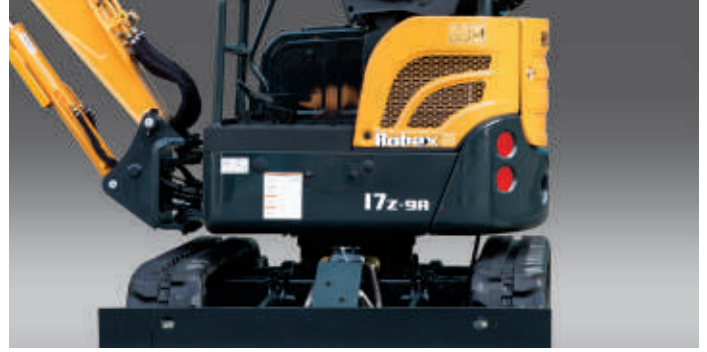

## Zero-Tail Swing

The Zero-tail swing excavator allows you greater flexibility when working in narrow urban areas from an alley and indoor to residential and small gardens.

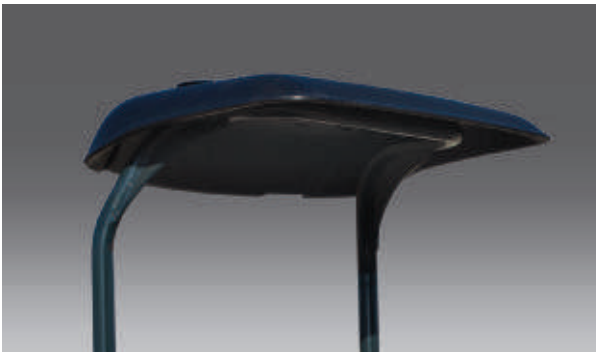

## Structure Strength

The R17Z-9A canopy structure has been fitted with stronger but slimmer tubing for added safety and improved visibility. Low-stress, high strength steel is integrally welded to form a stronger, more durable upper and lower frame. Structural integrity was tested by rear machine test and long-term durability tests.

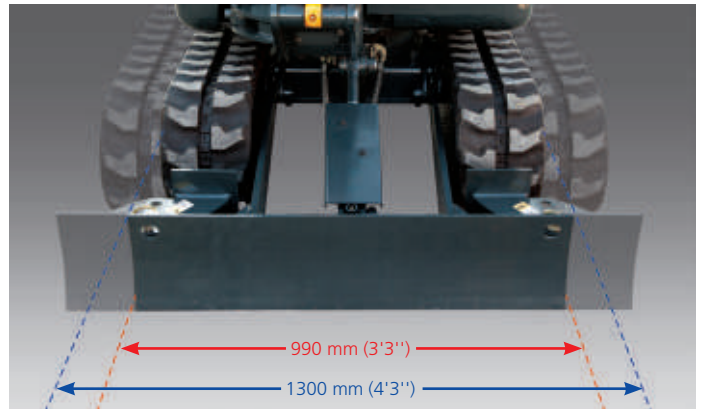

## Variable Undercarriage

The R17Z-9A's track width adjusts to between 990 mm ~ 1,300 mm (3'3"~ 4'3"). The operator can easily adjust the blade size by removing the pin. Specially designed rubber-padded track shoes protect the road surface.



## Kubota D902

**Emissions:** The most compact multi-cylinder liquid cooled industrial diesel engines comply with EPA Tier 4 Emission regulations without additional After Treatment Tools. This engine meets standards over the NRTC and NTE requirements.

**Lower Noise Level:** The half-float valve cover and MoS<sub>2</sub> coated piston reduce noise levels and vibration.

# Profitability

The R17Z-9A is designed to maximize profitability through improved efficiencies, enhanced service features and longer life components.



\*Photo may include optional equipment.





## Easy Access

The R17Z-9A was built with accessibility in mind. All covers and hoods were built for complete open access. Regular service and maintenance is easy and convenient with the R17Z-9A.

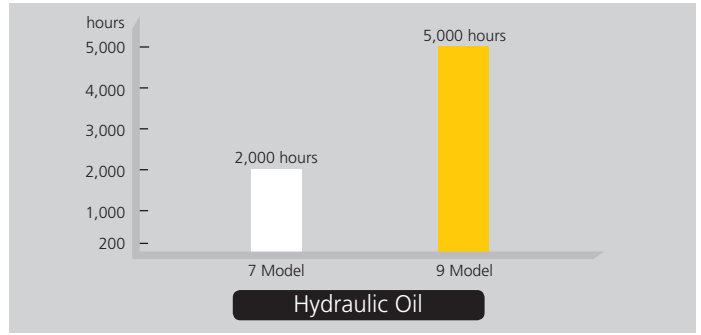

## Extended the Life of Components

9A series excavators were designed with bushings designed for extended lube intervals (250 hrs) & polymer shims (wear resistant, noise reducing), extended-life hydraulic filters (1,000 hrs), long-life hydraulic oil (5,000 hrs), more efficient cooling systems and integrated preheating systems which extend service intervals, minimize operating costs and reduce machine down time.



## Cooler Cleaning at Ease

The Square Wave Fin and the Corrugate Wave Fin to prevent clogging, were applied to the radiator and the oil cooler.



## Centralized Grease Fittings

Centralized lubrication bank for faster, easier service and maintenance.



## Two-Piece Hose for the Dozer Cylinder

Two piece hoses were applied for a better and easier maintenance.



## Easier to Transport

Four tying-down holes allow easier transportation.



## Protection Covers for Cylinders

The standard boom cylinder cover and the dozer cylinder cover was applied to protect cylinders from potential damages.

# Specifications R17Z-9A

## ENGINE

MODEL	KUBOTA D902		
Type	4 cycle, In line, Water cooled, Diesel, Tier 4 certified		
Rated flywheel horse power			
SAE	J1995 (gross)	16.8 hp (12.5 kW) / 2,300 rpm	
	J1349 (net)	15.8 hp ( 11.8 kW) / 2,300 rpm	
DIN	6271/1 (gross)	16.5 ps ( 13.1 kW) / 2,300 rpm	
	6271/1 (net)	16.0 ps (11.8 kW) / 2,300 rpm	
Max. torque	5.46 kgf.m (39.5 lbf.ft) / 1,900 rpm		
Bore x stroke	72 mm x 73.6 mm (2.83" x 2.89")		
Piston displacement	898 cc (54.79 in <sup>3</sup> )		
Batteries	12 V - 45 Ah		
Starting motor	12 V - 1.2 kW		
Alternator	12 V - 40 A		

## HYDRAULIC SYSTEM

MAIN PUMP	
Type	Variable displacement piston pumps
Max. flow	2 x 18.8 l/min + 11.3 l/min
Sub-pump for pilot circuit	Gear pump
HYDRAULIC MOTORS	
Travel	Two speed axial piston motor with counter balance valve
Swing	Axial piston motor
RELIEF VALVE SETTING	
Implement circuits	210 kgf/cm <sup>2</sup> (2,987 psi)
Travel	210 kgf/cm <sup>2</sup> (2,987 psi)
Swing circuit	170 kgf/cm <sup>2</sup> (2,418 psi)
Pilot circuit	35 kgf/cm <sup>2</sup> (498 psi)
Service valve	Installed

## HYDRAULIC CYLINDERS

No. of cylinder- bore x stroke	
Boom	60 x 440 mm (2.3" x 17.3")
Arm	60 x 353 mm (2.3" x 13.8")
Bucket	55 x 320 mm (2.16" x 12.59")
Boom swing	55 x 355 mm (2.16" x 13.97")
Dozer blade	65 x 45 mm (2.5" x 4.5")
Extension	55 x 310 mm (2.16" x 12.2")

## OPERATOR'S CAB

Noise Levels (dynamic value)	
Outside cabin - LwA	93 dB
Inside cabin - LpA	81 dB

## COOLANT & LUBRICANT CAPACITY

(refilling)	liter	US gal	UK gal
Fuel tank	20	5.3	4.4
Engine coolant	3.5	0.9	0.7
Engine oil	3.7	1.0	0.8
Hydraulic tank	13	3.4	2.9

## TRAVEL LEVERS

Traveling and steering : Two levers with pedals.

## HYDRAULIC CONTROLS

Type	Two joysticks with one safety lever
Pilot control	(LH): Swing and arm, (RH): Boom and bucket with horn (ISO)
Engine throttle	Mechanical, cable type

## SWING SYSTEM

Swing motor	Orbit motor
Swing reduction	-
Swing circuit lubrication	Lubricated with drain oil
Swing speed	9.5 rpm

## DRIVES & BRAKES

Max. travel speed (high) / (low)	4.1 km/h / 2.2 km/h (2.5 mph) / (1.4 mph)
Maximum traction force	1.42 ton
Maximum gradeability	30°

## DIGGING FORCE (ISO)

	0.96 m Arm	1.12 m Arm
Bucket	1,580 kgf	1,580 kgf
	15.5 kN	15.5 kN
	3,490 lbf	3,490 lbf
Arm	870 kgf	780 kgf
	8.5 kN	7.6 kN
	1,920 lbf	1,720 lbf

## OPERATING WEIGHT (APPROXIMATE)

Operating weight, including 1,800 mm (5' 11") boom, 960 mm (3' 2") arm, SAE heaped 0.04 m<sup>3</sup> (0.05 yd<sup>3</sup>) excavator bucket, lubricant, coolant, full fuel tank, full hydraulic tank, and all standard equipments.

Shoe Width	Rubber shoe 230 mm (9")
Operating Weight	Canopy 1,700 kg (3,747 lb)
Ground Pressure	Canopy 0.25 kg/cm <sup>2</sup> (3.98 psi)

## UNDERCARRIAGE

X-leg type center frame is integrally welded with reinforced box-section track frames. The undercarriage includes lubricated rollers, track adjusters with shock absorbing springs and sprockets and rubber shoes.

Track frame	Variable undercarriage
No. of track roller on each side	3 EA

# Dimensions & Working Ranges

## DIMENSIONS R17Z-9A

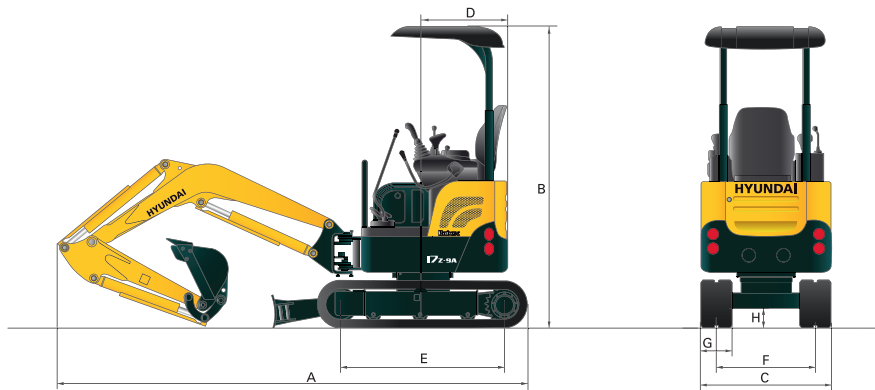

mm (ft · in)

<b>A</b> Overall length - Standard Arm	3,480 (11'4")	<b>D</b> Tail swing radius - additional counterweight	720 (2'3")
Overall length - Long Arm	3,510	<b>E</b> Tumbler distance	1,230 (4'0")
<b>B</b> Overall height	2,320 (7'7")	<b>F</b> Track gauge	760 ~ 1,070 (2'6" ~ 3'5")
<b>C</b> Overall width	990 ~ 1,300 (3'2" ~ 4'2")	<b>G</b> Track shoe width	230 (0'9")
<b>D</b> Tail swing radius - standard counterweight	645 (2'11")	<b>H</b> Ground clearance	170 (0'5")

## WORKING RANGES R17Z-9A

mm (ft · in)

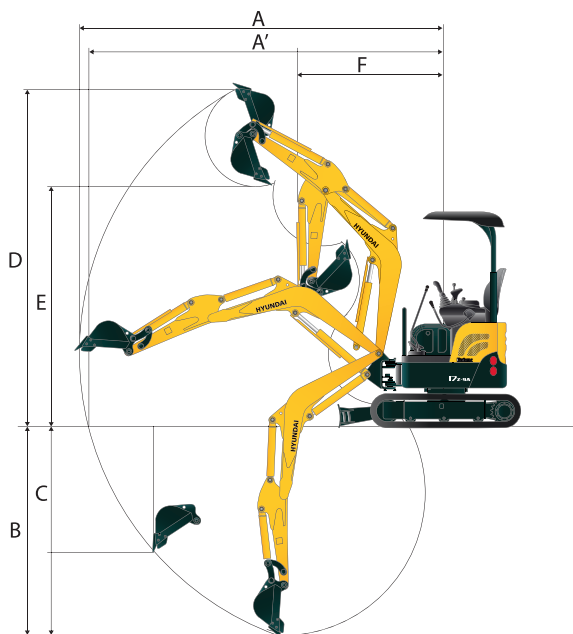









Boom length	1,800 (5'11")	
Arm length	960 (3'2")	1,120 (3'8")
<b>A</b> Max. digging reach	3,900 (12'7")	4,030 (13'2")
<b>A'</b> Max. digging reach on ground	3,800 (12'4")	3,940 (12'9")
<b>B</b> Max. digging depth	2,200 (7'2")	2,350 (7'7")
<b>C</b> Max. vertical wall digging depth	1,320 (4'3")	1,460 (6'3")
<b>D</b> Max. digging height	3,580 (11'7")	3,680 (12'0")
<b>E</b> Max. dumping height	2,570 (8'4")	2,670 (8'7")
<b>F</b> Min. front swing radius	1,570 (5'1")	1,600 (5'2")

# Lifting Capacities









## R17Z-9A

 Rating over-front  Rating over-side or 360 degrees

Boom : 1.80 m (5' 11") / Arm : 0.96 m (3' 2") / Bucket : 0.04 m<sup>3</sup> SAE heaped / Dozer up, Track extended, 230 mm (9") Rubber track, without additional counterweight

Load point height m (ft)		Load radius						At max. reach		
		2.0 m (7.0 ft)		2.5 m (8.0 ft)		3.0 m (10.0 ft)		Capacity		Reach m (ft)
										
3.0 m (10.0 ft)	kg lb							280 620	*290 *640	2.63 (8.6)
2.5 m (8.0 ft)	kg lb			310 680	*310 *680			200 440	210 460	3.13 (10.3)
2.0 m (7.0 ft)	kg lb			300 660	310 680	210 460	220 490	170 370	180 400	3.43 (11.3)
1.5 m (5.0 ft)	kg lb	430 950	440 970	290 640	300 660	210 460	220 490	150 330	160 350	3.60 (11.8)
1.0 m (3.0 ft)	kg lb	400 880	410 900	270 600	290 640	200 440	210 460	140 310	150 330	3.67 (12.0)
0.5 m (2.0 ft)	kg lb	370 820	390 860	260 570	270 600	190 420	200 440	140 310	150 330	3.64 (11.9)
Ground Line	kg lb	360 790	370 820	250 550	270 600	190 420	200 440	150 330	160 350	3.51 (11.5)
-0.5 m (-2.0 ft)	kg lb	360 790	370 820	250 550	260 570	190 420	200 440	170 370	180 400	3.27 (10.7)
-1.0 m (-3.0 ft)	kg lb	360 790	380 840	250 550	270 600			210 460	220 490	2.87 (9.4)
-1.5 m (-5.0 ft)	kg lb									

Boom : 1.80 m (5' 11") / Arm : 0.96 m (3' 2") / Bucket : 0.04 m<sup>3</sup> SAE heaped / Dozer down, Track extended, 230 mm (9") Rubber track, without additional counterweight

Load point height m (ft)		Load radius						At max. reach		
		2.0 m (7 ft)		2.5 m (8 ft)		3.0 m (10 ft)		Capacity		Reach m (ft)
										
3.0 m (10.0 ft)	kg lb							*290 *640	*290 *640	2.63 (8.6)
2.5 m (8.0 ft)	kg lb			*310 *680	*310 *680			*290 *640	220 490	3.13 (10.3)
2.0 m (7.0 ft)	kg lb			*320 *710	*320 *710	*320 *710	230 510	*300 *660	180 400	3.43 (11.3)
1.5 m (5.0 ft)	kg lb	*450 *990	*450 *990	*380 *840	310 680	*340 *750	230 510	*300 *660	160 350	3.60 (11.8)
1.0 m (3.0 ft)	kg lb	*620 *1370	430 950	*450 *990	300 660	*380 *840	220 490	*310 *680	150 330	3.67 (12.0)
0.5 m (2.0 ft)	kg lb	*740 *1630	400 880	*520 *1150	280 620	*410 *900	210 460	*320 *710	150 330	3.64 (11.9)
Ground Line	kg lb	*790 *1740	390 860	*550 *1210	270 600	*420 *930	210 460	*330 *730	160 350	3.51 (11.5)
-0.5 m (-2.0 ft)	kg lb	*760 *1680	390 860	*540 *1190	270 600	*400 *880	210 460	*330 *730	180 400	3.27 (10.7)
-1.0 m (-3.0 ft)	kg lb	*660 *1460	390 860	*470 *1040	270 600			*320 *710	230 510	2.87 (9.4)
-1.5 m (-5.0 ft)	kg lb	*450 *990	400 880							











- Lifting capacity is based on SAE J1097, ISO 10567.
- Lifting capacity of the Robex Series does not exceed 75% of the tipping load with the machine on firm, level ground or 87% of full hydraulic capacity.
- The load point is a hook located on the back of the bucket.
- (\*) indicates the load limited by hydraulic capacity.

# Lifting Capacities











## R17Z-9A

 Rating over-front  Rating over-side or 360 degrees

Boom : 1.80 m (5' 11") / Arm : 1.12 m (3' 8") / Bucket : 0.04 m<sup>3</sup> SAE heaped / Dozer up, Track extended, 230 mm (9") Rubber track, without additional counterweight

Load point height m (ft)		Load radius								At max. reach		
		2.0 m (7.0 ft)		2.5 m (8.0 ft)		3.0 m (10.0 ft)		3.5 m (12.0 ft)		Capacity		Reach
												m (ft)
3.0 m (10.0 ft)	kg lb									240 530	250 550	2.87 (9.4)
2.5 m (8.0 ft)	kg lb			*260 *570	*260 *570					180 400	190 420	3.31 (10.9)
2.0 m (7.0 ft)	kg lb			*280 *620	*280 *620	210 460	220 490			150 330	160 350	3.59 (11.8)
1.5 m (5.0 ft)	kg lb	*380 *840	*380 *840	290 640	300 660	210 460	220 490			140 310	140 310	3.75 (12.3)
1.0 m (3.0 ft)	kg lb	400 880	420 930	280 620	290 640	200 440	210 460	150 330	160 350	130 290	140 310	3.82 (12.5)
0.5 m (2.0 ft)	kg lb	370 820	390 860	260 570	270 600	190 420	200 440	150 330	150 330	130 290	140 310	3.79 (12.4)
Ground Line	kg lb	360 790	370 820	250 550	260 570	190 420	200 440			130 290	140 310	3.67 (12.0)
-0.5 m (-2.0 ft)	kg lb	350 770	370 820	240 530	260 570	180 400	190 420			150 330	160 350	3.45 (11.3)
-1.0 m (-3.0 ft)	kg lb	350 770	370 820	250 550	260 570					180 400	190 420	3.08 (10.1)
-1.5 m (-5.0 ft)	kg lb	360 790	380 840							270 600	*280 *620	2.47 (8.1)

Boom : 1.80 m (5' 11") / Arm : 1.12 m (3' 8") / Bucket : 0.04 m<sup>3</sup> SAE heaped / Dozer down, Track extended, 230 mm (9") Rubber track, without additional counterweight

Load point height m (ft)		Load radius								At max. reach		
		2.0 m (7.0 ft)		2.5 m (8.0 ft)		3.0 m (10.0 ft)		3.5 m (11.0 ft)		Capacity		Reach
												m (ft)
3.0 m (10.0 ft)	kg lb									*270 *600	260 570	2.87 (9.4)
2.5 m (8.0 ft)	kg lb			*260 *570	*260 *570					*270 *600	200 440	3.31 (10.9)
2.0 m (7.0 ft)	kg lb			*280 *620	*280 *620	*290 *640	230 510			*270 *600	170 370	3.59 (11.8)
1.5 m (5.0 ft)	kg lb	*380 *840	*380 *840	*340 *750	310 680	*320 *710	230 510			*280 *620	150 330	3.75 (12.3)
1.0 m (3.0 ft)	kg lb	*550 *1210	430 950	*420 *930	300 660	*350 *770	220 490	*250 *550	160 350	*290 *640	140 310	3.82 (12.5)
0.5 m (2.0 ft)	kg lb	*700 *1540	400 880	*490 *1080	280 620	*390 *860	210 460	*270 *600	160 350	*300 *660	140 310	3.79 (12.4)
Ground Line	kg lb	*770 *1700	390 860	*540 *1190	270 600	*410 *900	200 440			*310 *680	150 330	3.67 (12.0)
-0.5 m (-2.0 ft)	kg lb	*770 *1700	380 840	*540 *1190	270 600	*410 *900	200 440			*310 *680	160 350	3.45 (11.3)
-1.0 m (-3.0 ft)	kg lb	*700 *1540	380 840	*500 *1100	270 600					*310 *680	200 440	3.08 (10.1)
-1.5 m (-5.0 ft)	kg lb	*530 *1170	390 860							*280 *620	*280 *620	2.47 (8.1)

- Lifting capacity is based on SAE J1097, ISO 10567.
- Lifting capacity of the Robex Series does not exceed 75% of the tipping load with the machine on firm, level ground or 87% of full hydraulic capacity.
- The load point is a hook located on the back of the bucket.
- (\*) indicates the load limited by hydraulic capacity.





## STANDARD EQUIPMENT R17Z-9A

### ISO standard canopy

canopy ROPS (ISO 3471)  
FOPS (ISO 3449)  
FOG (ISO 10262 Level I)  
TOPS (ISO 12117)

### Centralized monitoring

#### Gauges

Fuel level gauge  
Engine coolant temperature gauge

#### Warning lamps

Quick clamp  
Engine oil pressure  
Engine coolant temperature  
Preheat engine  
Low battery  
Fuel empty

#### One key fits all

#### Mechanical suspension seat with seat belt

#### Console box tilting system (LH.)

#### Two front working lights

#### Electric horn

#### Battery (1 x 12 V x 80 Ah)

#### Battery master switch

#### Removable reservoir tank

#### Water separator, fuel line

#### Mono boom (1.80 m; 5' 11")

#### Arm (0.96 m; 3' 2")

#### Rubber crawler (230 mm; 9")

#### Double acting piping

## OPTIONAL EQUIPMENT R17Z-9A

### Accumulator, work equipment lowering

### Travel alarm

### Tool kit

### Lever pattern change valve

### Long arm (1.12 m; 3' 8")

### Heater & Defroster

### Quick coupler piping

### Quick coupler

### Proportional control

### Additional Counterweight

- \* Standard and optional equipment may vary. Contact your Hyundai dealer for more information. The machine may vary according to international standards.
- \* The photos may include attachments and optional equipment that are not available in your area.
- \* Materials and specifications are subject to change without advance notice.
- \* All imperial measurements rounded off to the nearest pound or inch.

PLEASE CONTACT

